

Cord Operated Curtain Track Systems





Cord Operated Curtain Track System

Silent Gliss® 3840

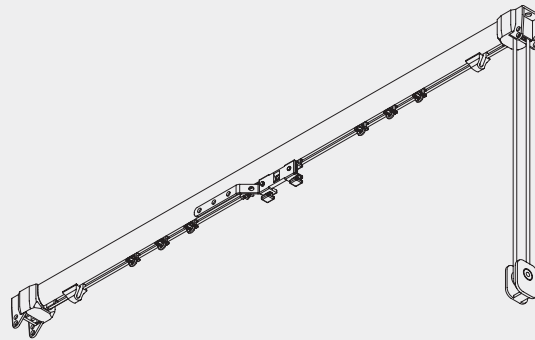

Product Information

- Operation: cord drawn
- Range: M
- Fitting: ceiling, wall
- Colours: white, matt white, silver anodised, anodic grey, charcoal and antique bronze
- Shape: oval
- 2C glider technology
- Wave compatible
- Bendable
- Complies with safety norms EN 13120, EN 16433 and EN 16434



3840

Profile, Bending and Specification Information

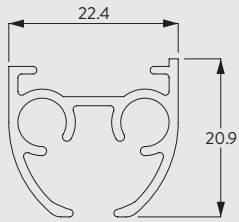

3841



Standard radius 200mm

Specification Guide- download from www.silentgliss.co.uk (password required).

Silent Gliss 3840 curtain track, cord drawn, anodised aluminium, assembled complete with 2C gliders 11301 at 14/m. cord guide return set 3845, pilot runners 3842/3, overlap 6288 and cord 3090, (cord drop 150mm R.H.S.). Top fix with special fixing clamp 3825/bracket 3832 at max. 500mm centre each screwed to timber/plugged and screwed to block/concrete.Lm. Silent Gliss 3840R, as above except with 6283 roller gliders at 10/m.

How to measure

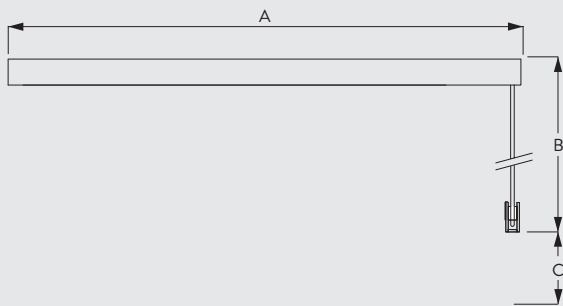

A: system width

B: cord height

C: cord retainer 10400 must be installed at least 150cm above the floor (ref: EN13120 Child Safety)

Stack depth Wave

3840

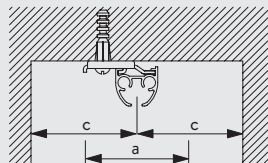
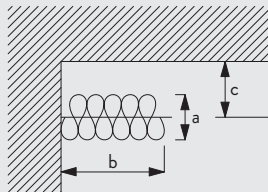

a = Stack depth
b = Stack size
c = Min. distance

Wave standard

Glider-cord spacing	Curtain hook spacing	Approx. curtain fullness	Stack depth (a)	Stack width (b)	Min distance (c)
6	10	2.1	10	23 per metre of track + endpiece	8
6	12	2.3	12	23 per metre of track + endpiece	9
8	14	2.1	14	18 per metre of track + endpiece	10
8	16	2.3	16	18 per metre of track + endpiece	11

Wave standard with roller gliders

Glider-cord spacing	Curtain hook spacing	Approx. curtain fullness	Stack depth (a)	Stack width (b)	Min distance (c)
8	14	2.1	14	21 per metre of track + endpiece	10
8	16	2.3	16	21 per metre of track + endpiece	11

(dimensions in cm)

Note: Minimum distance (c) includes a standard 3cm clearance (front and back).

System Dimensions

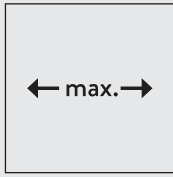

6m



14kg (roller glider)

Max. Curtain Weight Chart - 2C glider and roller

	2 m	4 m	6 m
	12	11	10
	14	13	12
	9	8	7
	10	9	6
	6	5	4
	7	6	5
	5	4	3
	6	5	4

(kg max.)

Max. Curtain Weight Chart - Wave 2C glider cord and glider

	2 m	4 m	6 m
	5	8	7
	5	8	8
	5	6	5
	5	6	6
	4	3	2
	4	4	3
	3	2	1
	3	3	2

(load limitation max. 2.5 kg per m)

Straight tracks can be extended beyond 6m by using a connecting bridge and intermediate pulley.



3840

System Options

Wave Standard curtain heading system

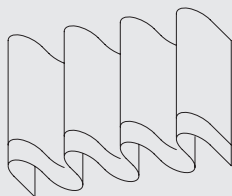

Wave is an exciting new contemporary curtain heading system which allows curtains to hang in a continuous wave which is smooth, simple and elegant.

When using the Wave curtain heading system please note the maximum recommended curtain weight is 2.5kg/m. **A greater weight may be achieved using wave roller glider 6099 (refer to System Dimensions).**

The Wave standard components are:

11303 Glider Cord 60mm
 11302 Glider Cord 80mm
 6007 End stop
 6315 Pilot runner

The items listed below for Enhanced Wave (80mm glider cord only) are all supplied at an additional cost as per the price list.

2255 Adjustable brake
 6364 Extension (used with 6365)
 6365 Hanger (used with 6364)
 6366 Carrier for draw rod

Roller Gliders must be ordered separately
 6099 Wave roller glider 80mm

Optional components to improve the presentation of the curtain:

3582 Hook
 6349 Curtain tape
 6363 Iron-on top hemming tape
 10075 Lead weight for hem of curtain 50gr/m
 10076 Fabric weight for side edge of curtain

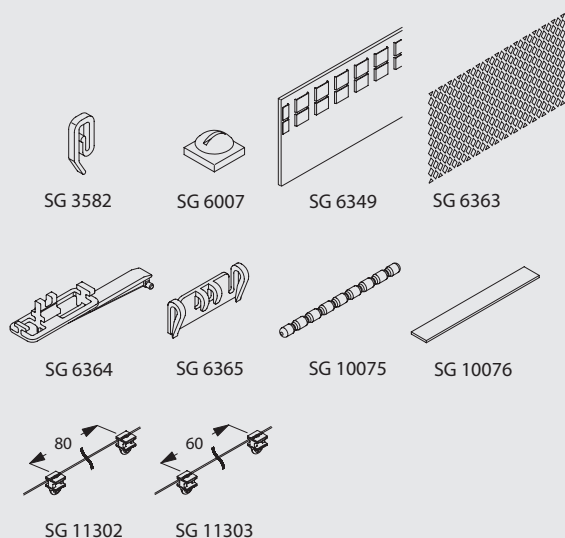

3840

Child Safety Device

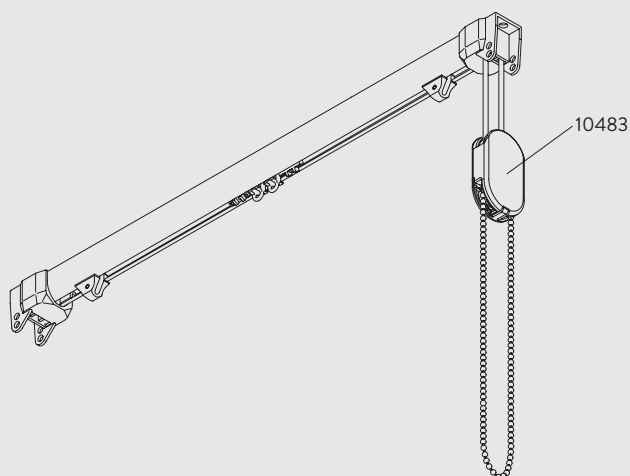

The child safety device SG 10483 releases the chain should the pulling force exceed 6kg. Uses a 4mm metal bead chain.

Please note: Child safety device is only applicable with white cord SG 3090.

Max. curtain weight with child safety device

Standard Application with Glider / Wave & Wave XL

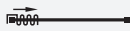
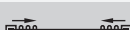
	2 m	3 m	4 m	5 m	6 m
	2	3	4	3	2
	2	3	4	4	4

(kg max.)

Standard Application with Roller SG 6098

	2 m	3 m	4 m	5 m	6 m
	3	4	5	5	6
	3	4	5	6	7

(kg max.)

Fitting Information

WARNING

Young children can be strangled by loops in pullcords, chains, tapes and inner cords that operate the product. To avoid strangulation and entanglement, keep cords out of the reach of young children. Cords may become wrapped around a child's neck. Move beds, cots and furniture away from window covering cords. Do not tie cords together. Make sure cords do not twist to create a loop.

Bracket and profile positioning

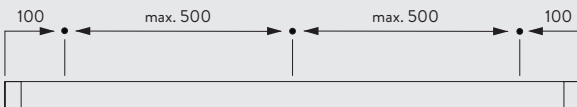

The measurements stated are offered as a guide only and will vary depending on curtain weight. For heavy curtains it is recommended that fixing points are 300mm max.

3840

Fitting of clamp 3825

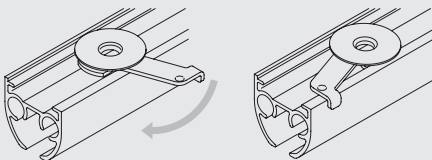

Higher edge of profile to the room side / clamp arm to the window.
Minimum clearance from back of profile is 17mm to allow for rotation.

Fitting of bracket 3832

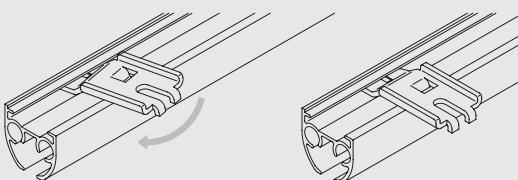

Fitting Options

Ceiling fix with clamp 3825

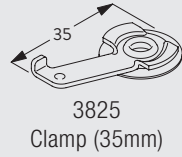
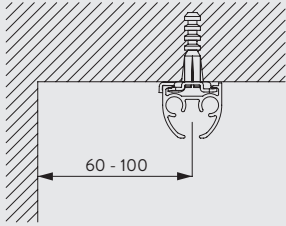

The final distances may be outside of the recommendations above depending on curtain heading, make-up and any obstructions.

Ceiling fix with bracket 3832

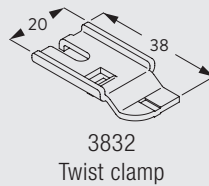
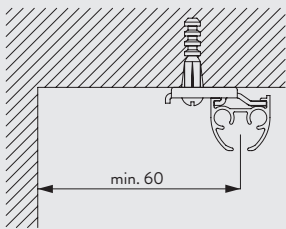

The final distances may be outside of the recommendations above depending on curtain heading, make-up and any obstructions.

Ceiling fix with bracket 3826

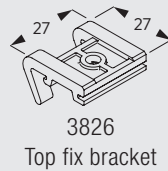
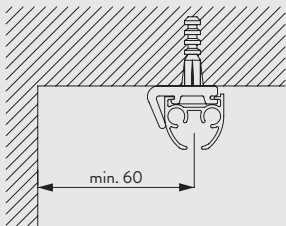

The final distances may be outside of the recommendations above depending on curtain heading, make-up and any obstructions.

Wall fitting with Smart Fix 11200-11205 and bracket 3826

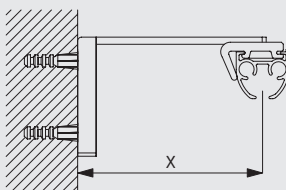

	X (mm)
11200	52
11201	72
11202	92
11203	112
11204	142
11205	192

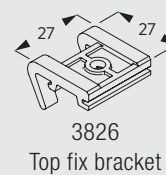
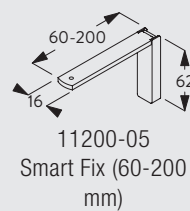

Brackets feature thread for screw M4x8 for fixing bracket SG 3826.

Wall fitting with Square Smart Fix 11210-11215 and bracket 3826

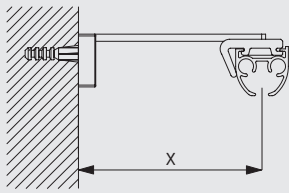

	x (mm)
11210	52
11211	72
11212	92
11213	112
11214	142
11215	192

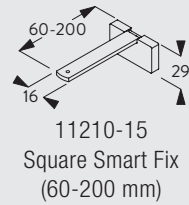

11210-15
Square Smart Fix
(60-200 mm)

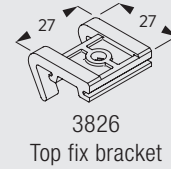

3826
Top fix bracket

Brackets feature thread for screw M4x8 for fixing bracket SG 3826.

Wall fitting with Universal Smart Fix 11154-11156 and bracket 3826

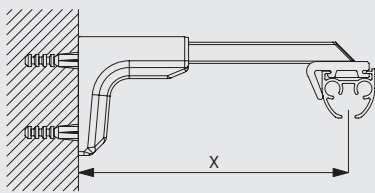

	X (mm)
11154	102-130
11155	132-160
11156	182-210

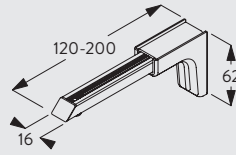

11154-56
Universal Smart Fix
(120-200 mm)

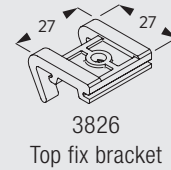

3826
Top fix bracket

Brackets feature thread for screw M4x12 for fixing bracket SG 3826.

Wall fitting with bracket 3836

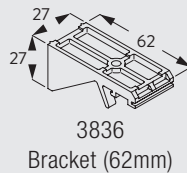
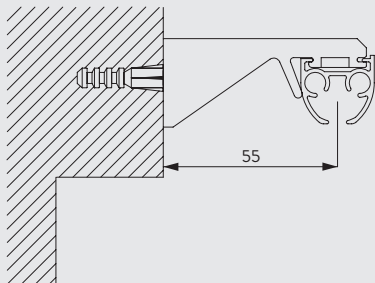

3836
Bracket (62mm)

Standard Accessories

3090	Cord (ø 3.5mm)		3825	Clamp (35mm)	
3841	Profile		6086	Spring stop	
6288	Overlap arm		10400	Safety Cord Retainer	
11301	2C glider 11300 on strip (x20)		1148C	Countersunk screw	

3840

Sets

3845	Cord guide set, containing	3804	Cord guide	2	
		6314	Pilot runner	1	
		6315	Pilot runner	1	

Optional Accessories

3151	Pelmet spacer (was 0516)		3802	Connecting bridge	
3826	Top fix bracket		3832	Twist clamp	
3833	Intermediate pulley guide		3836	Bracket (62mm)	
6007	Endstop		6053	Spring stop	
6063	Metal overlap arm		6064	Screw twist endstop	
6094	Roller glider with hook		6098	Roller glider with eye	
6283	Roller glider		6315	Pilot runner	
6382	Limit stop		6398	Clip	
10483	Child Safety Device - Cord to 4mm Metal Bead Chain		11154	Universal Smart Fix, 120 mm set	
11155	Universal Smart Fix, 150 mm set		11156	Universal Smart Fix, 200 mm set	
11200	Smart Fix, 60 mm set		11201	Smart Fix, 80 mm set	
11202	Smart Fix, 100 mm set		11203	Smart Fix, 120 mm set	
11204	Smart Fix, 150 mm set		11205	Smart Fix, 200 mm set	
11210	Square Smart Fix, 60 mm set		11211	Square Smart Fix, 80 mm set	

3840

11212 Square Smart Fix, 100 mm set

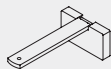

11213 Square Smart Fix, 120 mm set

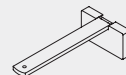

11214 Square Smart Fix, 150 mm set

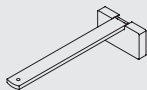

11215 Square Smart Fix, 200 mm set

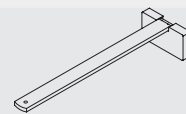

Sets

3846 Cord guide set with return, containing

3816 Corner cord guide 2



6314 Pilot runner 1



6315 Pilot runner 1



Wave Accessories

2255 Adjustable brake



6099 Wave roller glider cord (80mm)

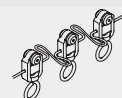

6349 Curtain tape



6363 Top hemming tape



6364 Extension

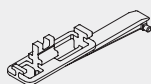

6365 Hanger



6366 Wave carrier for draw rod

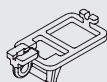

10075 Lead weight 50 gr/m

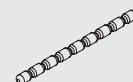

10076 Fabric weight



11302 Wave 2C glider cord 80 mm



11303 Wave 2C glider cord 60 mm



3840

Useful Measures

10483 Child Safety Device - Cord to 4mm Metal Bead Chain

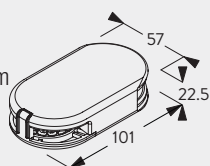

www.silentgliss.co.uk

www.silentglissglobal.com

Silent Gliss Ltd
Pyramid Business Park
Poorhole Lane
Broadstairs
Kent
CT10 2PT
Great Britain

Tel: +44 (0) 1843 863571
Fax: +44 (0) 1843 864503
info@silentgliss.co.uk

Silent Gliss Global Ltd
Pyramid Business Park
Poorhole Lane
Broadstairs
Kent
CT10 2PT
Great Britain

Tel: +44 (0) 1843 874250
Fax: +44 (0) 1843 874457
info@silentglissglobal.com