

Hand Operated Curtain Track System

Silent Gliss® 6010

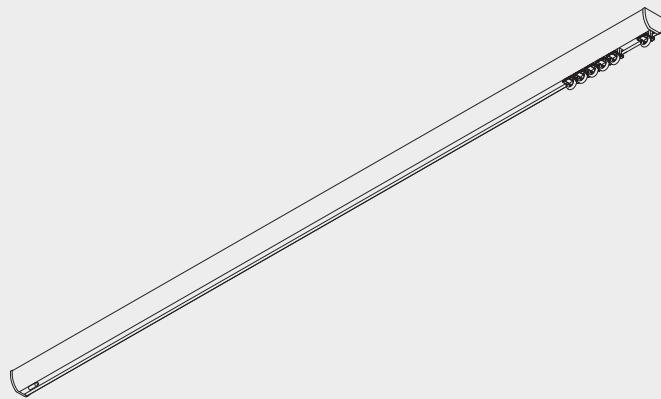

Product Information

- Operation: hand drawn
- Size range: M
- Colours: white
- Shape: oval
- 2C glider technology
- Wave compatible
- Bendable



6010

Profile and Bending Information

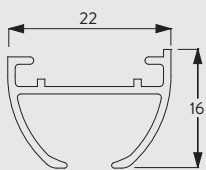

6010



Minimum radius 15cm.

How to measure

Stack depth Wave Standard

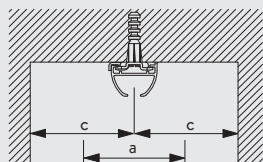
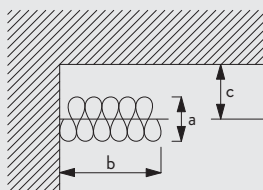

a = Stack depth
b = Stack size
c = Min. distance

Glider-cord spacing	Curtain hook spacing	Approx. curtain fullness	Stack depth (a)	Stack width (b)	Min distance (c)
6	10	2.1	10	23 per metre of track + endpiece	8
6	12	2.3	12	23 per metre of track + endpiece	9
8	14	2.1	14	18 per metre of track + endpiece	10
8	16	2.3	16	18 per metre of track + endpiece	11

Wave standard with roller gliders

Glider-cord spacing	Curtain hook spacing	Approx. curtain fullness	Stack depth (a)	Stack width (b)	Min distance (c)
8	14	2.1	14	21 per metre of track + endpiece	10
8	16	2.3	16	21 per metre of track + endpiece	11

(dimensions in cm)

Note: Minimum distance (c) includes a standard 3cm clearance (front and back).

System Options

Wave curtain heading system

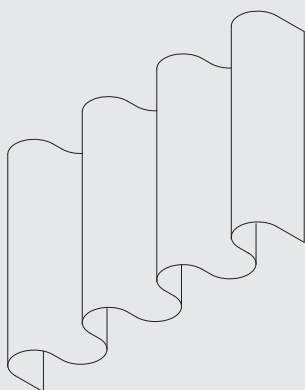

The Wave is an exciting contemporary curtain heading system which allows curtains to hang in a continuous wave which is smooth, simple and elegant.

The Wave standard components are:

- 11303 Wave 2C Glider Cord 60mm
- 11302 Wave 2C Glider Cord 80mm
- 6007 End stop
- 6315 Pilot runner

The items listed below for Enhanced Wave (80mm glider cord only) are all supplied at an additional cost as per the price list.

- 2255 Adjustable brake
- 6364 Extension (used with 6365)
- 6365 Hanger (used with 6364)
- 6366 Carrier for draw rod

Roller Gliders must be ordered separately
6099 Wave roller glider 80mm

Optional components to improve the presentation of the curtain:

- 3582 Hook
- 6349 Curtain tape
- 6363 Iron-on top hemming tape
- 10075 Lead weight for hem of curtain 50gr/m
- 10076 Fabric weight for side edge of curtain

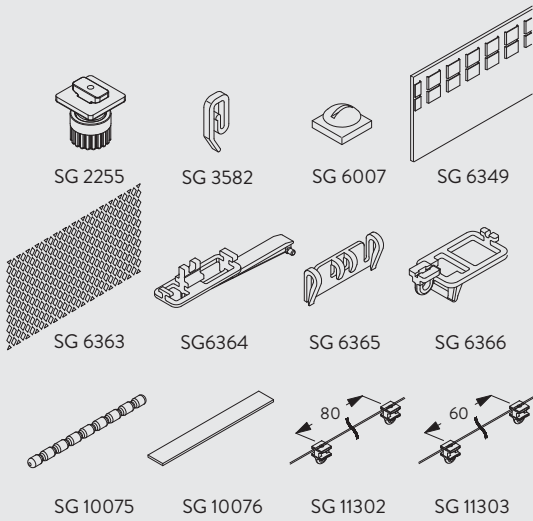

Fitting Information

Ceiling fixing with clamp 3825

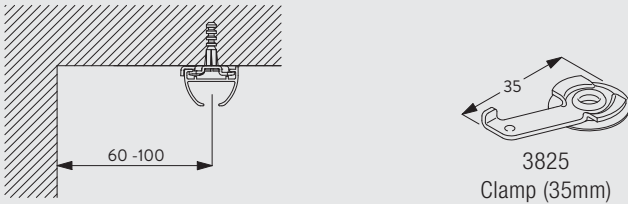

Fix track with at least one clamp 3825 every 300-600mm.
Higher edge of profile to room side. The final distances depend on system height and width and the way of confectioning.

Wall fitting with Smart Fix 11200-11205 and bracket 3832

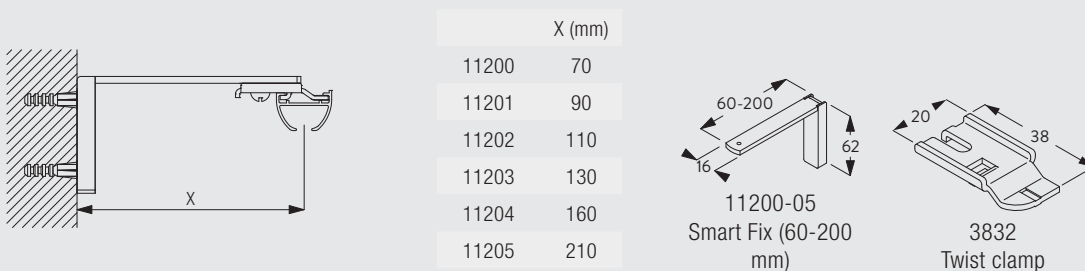

Brackets feature thread for screw SG M4x8

Wall fitting with Square Smart Fix 11210-11215 and bracket 3832

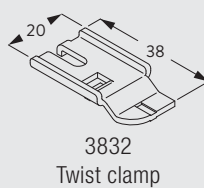
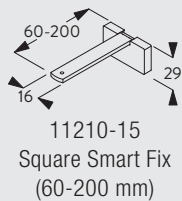
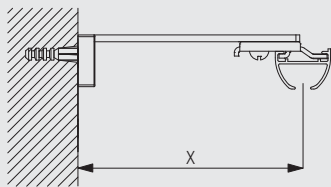

Brackets feature thread for screw SG M4x8

Wall fitting with Universal Smart Fix 11154-11156 and bracket 3832

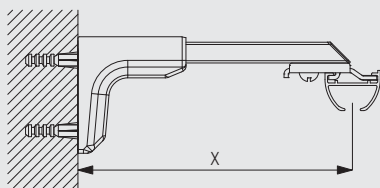

	X (mm)
11154	120-148
11155	150-178
11156	200-228

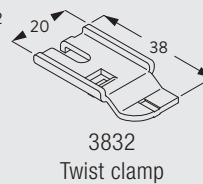
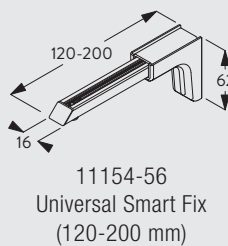

Brackets feature thread for screw SG M4x10

Standard Accessories

3825 Clamp (35mm)



6010 Profile



6018 Endcover



6065 Twist eye endstop



11301 2C glider 11300 on strip (x20)



1148C Countersunk screw

6010

Optional Accessories

3582 Hook



3802 Connecting bridge

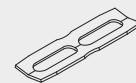

3832 Twist clamp

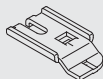

6098 Roller glider with eye



6283 Roller glider



11154 Universal Smart Fix, 120 mm set

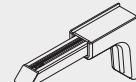

11155 Universal Smart Fix, 150 mm set

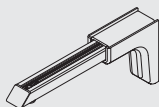

11156 Universal Smart Fix, 200 mm set

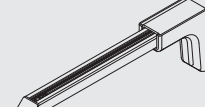

11200 Smart Fix, 60 mm set



11201 Smart Fix, 80 mm set



11202 Smart Fix, 100 mm set

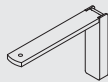

11204 Smart Fix, 150 mm set



11210 Square Smart Fix, 60 mm set



11212 Square Smart Fix, 100 mm set

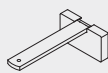

11214 Square Smart Fix, 150 mm set

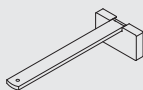

11203 Smart Fix, 120 mm set

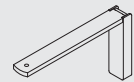

11205 Smart Fix, 200 mm set



11211 Square Smart Fix, 80 mm set

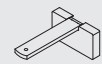

11213 Square Smart Fix, 120 mm set

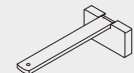

11215 Square Smart Fix, 200 mm set

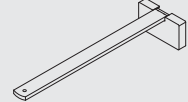

Wave Accessories

6099 Wave roller glider cord (80mm)



6363 Top hemming tape



10076 Fabric weight



11303 Wave 2C glider cord 60 mm

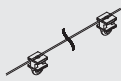

6349 Curtain tape



10075 Lead weight 50 gr/m

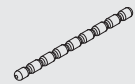

11302 Wave 2C glider cord 80 mm



Useful Measures

3802 Connecting bridge

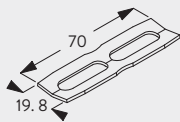

6018 Endcover

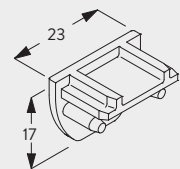

6010