

# Decorative Curtain Poles





## Hand Operated Curtain Pole System

# Silent Gliss® 6130M Metropole 30mm

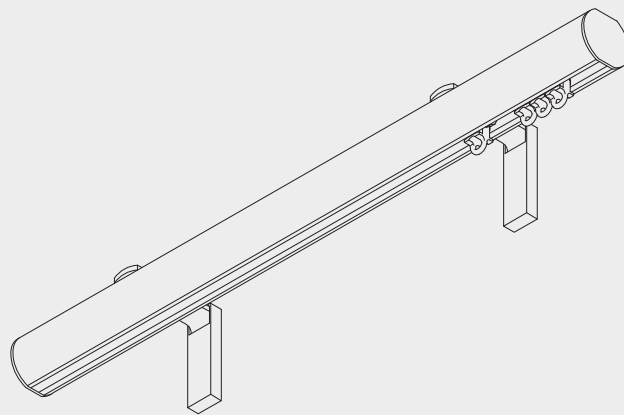

### Product Information

- Hand operated system for domestic and contract applications
- Unlike other poles, 6130 can be bent to a small radius for bay windows
- Choice of 15 different finishes - ecru, bronze, antique bronze, gunmetal, black, charcoal, anodic grey, slate grey, matt white, white, sand, ochre, chrome effect, anodised silver and taupe
- Metropole is available with a range of finials offering a contemporary or traditional finish
- Accessorised with matching end caps and co-ordinated or matching brackets/bracket covers
- Easy fitting to wall or ceiling
- For medium to heavy curtains
- Profile Length 6m (chrome effect 3.95m)
- Suitable for use with Wave Curtain heading systems

6130M

## Profile and Bending Information

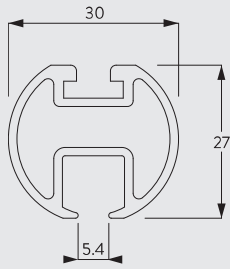

6103

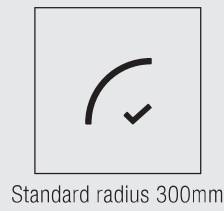

Standard radius 300mm

### Specification Guide - download from [www.silentgliss.co.uk](http://www.silentgliss.co.uk) (password required).

Silent Gliss 6130 curtain track, hand drawn, aluminium, assembled complete with gliders 6143 at 10/m and 2 endcovers 0346. Face fix with brackets 11206-208/11216-218/11209/0674/0334, top fix with bracket 6138P/0335 each screwed to timber/plugged and screwed to block-work/concrete at 600mm centres. Finished in ecru, bronze, antique bronze, gunmetal, black, charcoal, anodic grey, slate grey, matt white, white, sand, ochre, chrome effect, anodised silver or taupe

## How To Measure

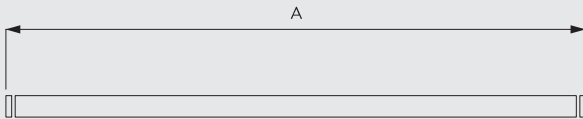

A: System Width - includes finials. See 'Design Options' for finial sizes.

## Stack Size Calculation Wave

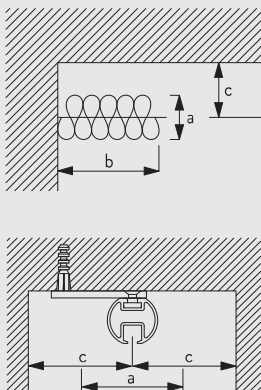

a = Stack depth  
b = Stack size  
c = Min. distance

Glider-cord spacing	Curtain hook spacing	Approx. curtain fullness	Stack depth (a)	Stack width (b)	Min distance (c)
6	10	2.1	10	23 per metre of track + endpiece	8
6	12	2.3	12	23 per metre of track + endpiece	9
8	14	2.1	14	18 per metre of track + endpiece	10
8	16	2.3	16	18 per metre of track + endpiece	11

Wave standard with roller gliders

Glider-cord spacing	Curtain hook spacing	Approx. curtain fullness	Stack depth (a)	Stack width (b)	Min distance (c)
8	14	2.1	14	21 per metre of track + endpiece	10
8	16	2.3	16	21 per metre of track + endpiece	11

(dimensions in cm)

Note: Minimum distance (c) includes a standard 3cm clearance (front and back).

## Design Options

### Endaps

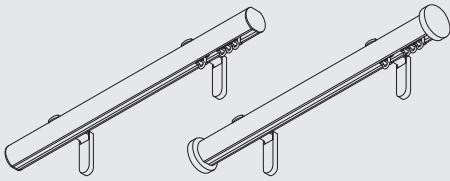

Without finials, poles are supplied as standard with flush fitting endcaps 0346 (left). Alternatively, stud endcaps 0707 (right) can be selected at no additional cost.

### Finials

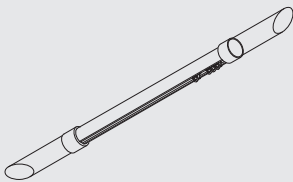

Finials are decorative elements that fit on at the end of the pole.

Please refer to the Metropole brochure for full range details.

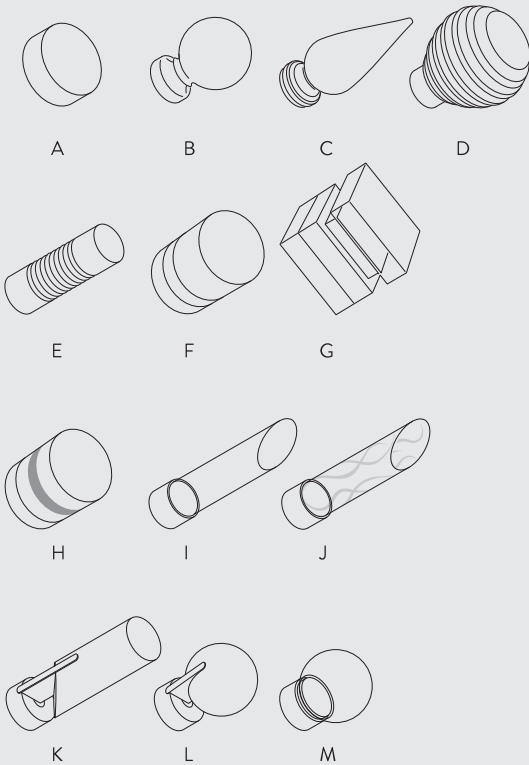

- A: 0873 Design Endcap 20mm
- B: 0556 Ball End 70mm
- C: 0719 Spear 135mm
- D: 0986 Groove Ball 85mm
- E: 0629 Groove Cylinder 85mm
- F: 0901 Strata 65mm
- G: 0886 Crystal Cube 55mm
- H: 0896 Crystal Cylinder 55mm
- I: 0995CL Shard Clear 127mm
- J: 0995ET Shard Etched 127mm
- K: 0311 Fused Barrel 102mm (walnut/oak/matched)
- L: 0324 Fused Ball 60mm (walnut/oak/matched)
- M: 0331 Glass Ball (clear/frosted) 55mm

6130M

## Wave Standard curtain heading system

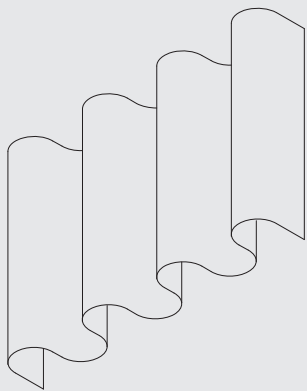

Wave Standard is an exciting contemporary curtain heading system which allows curtains to hang in a continuous wave which is smooth, simple and elegant.

When using the Wave curtain heading system please note the maximum recommended curtain weight is 2.5kg/m or 10kg/m with wave roller glider 6098W.

The Wave standard components are:

6345 Glider Cord 60mm  
6346 Glider Cord 80mm  
6007 End stop

The items listed below for Enhanced Wave (80mm glider cord only) are all supplied at an additional cost as per the price list.

2255 Adjustable brake  
6364 Extension (for use with 6365)  
6365 Hanger (for use with 6364)  
6366 Carrier for draw rod

Roller gliders must be ordered separately  
6098W Wave roller glider 80mm

Optional enhanced components to improve the presentation of the curtain:

3582 Hook  
6349 Curtain tape  
6363 Iron-on top hemming tape  
10075 Lead weight for bottom hem 50gr/m  
10076 Fabric weight for side of curtain

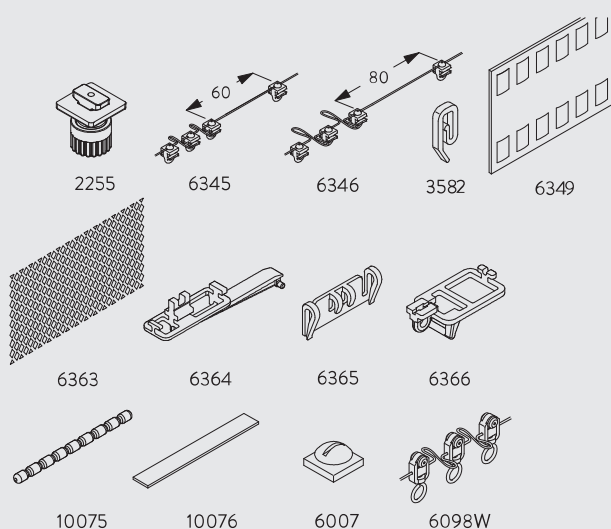

6130M

## Fitting Information

### Bracket positioning

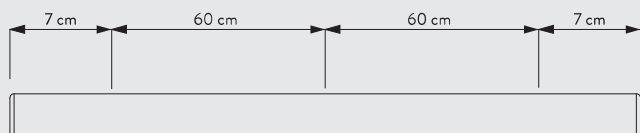

## Fitting of tracks to brackets

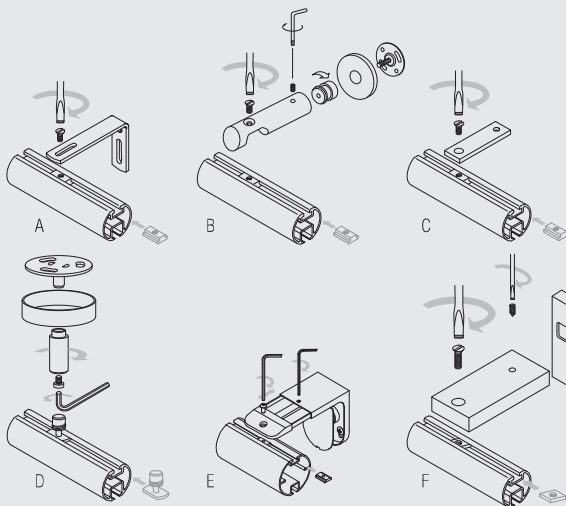

- A: Using bracket sets 11206-11208/11216-11218/11209
- B: Using pillar bracket 0674
- C: Using top fix plates 6138p/6138p2
- D: Using top fix bracket 0335
- E: Using maxi bracket 0334
- F: Using blok bracket 0989

## Fitting bent tracks

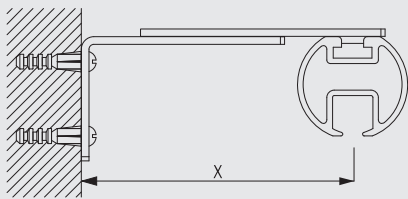

Note: all bent Metropole systems are supplied with adjustable bracket set 11209 as standard.

## Fitting Options

### Ceiling fix with support 6138P

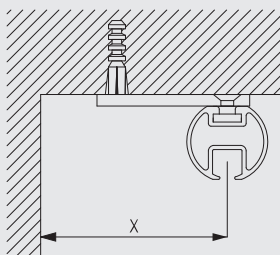

X (mm)  
80

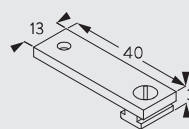

6138p  
Ceiling support set  
(3mm)

The final distances may be outside of the recommendations above depending on curtain make-up and any obstructions.

### Wall fix with adjustable Smartfix bracket 11209

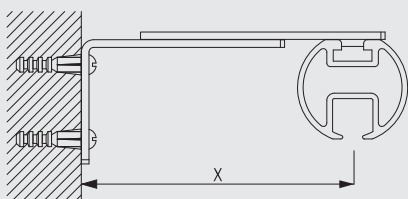

X (mm)  
11209 80-100

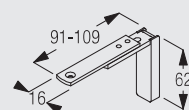

11209  
Smart Fix with  
extension arm set

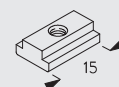

6141  
Track insert (uses  
screw 0798)

Note: all bent Metropole systems are supplied with adjustable bracket set 11209 as standard.

Brackets feature slot for screw M4x8

### Wall fix with Pillar bracket 0674

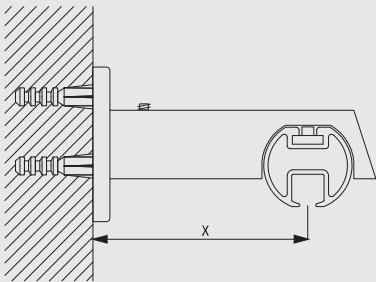

	X (mm)
0674	90

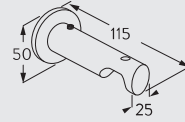

0674  
Pillar bracket (30 mm poles only)

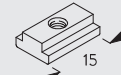

6141  
Track insert (uses screw 0798)

### Ceiling fix with top fix bracket 0335

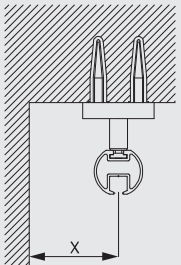

	X (mm)
0335	50

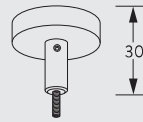

0335  
Top fix bracket

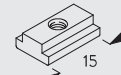

6141  
Track insert (uses screw 0798)

### Wall fix with maxi adjustable bracket 0334

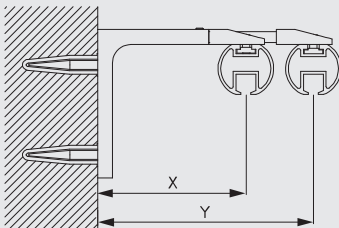

	X (mm)	Y (mm)
0334	80	100

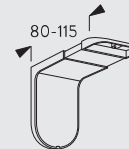

0334  
Maxi adjustable bracket

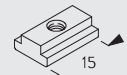

6141  
Track insert (uses screw 0798)

### Wall fitting with Smart Fix with slot 11206-11208

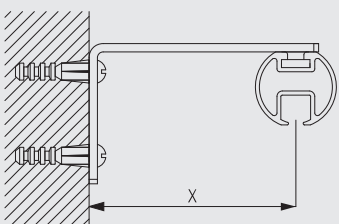

	X (mm)
11206	33-51
11207	53-71
11208	73-91

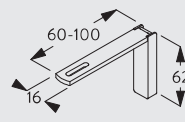

11206-08  
Smart Fix with slot (60-100 mm)

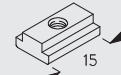

6141  
Track insert (uses screw 0798)

Brackets feature slot for screw M4x8

6130M



## Wall fitting with Square Smart Fix with slot 11216-11218

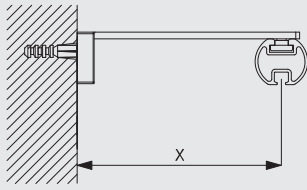

	X (mm)
11216	33-51
11217	53-71
11218	73-91

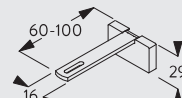

11216-18  
Square Smart Fix  
with slot (60-100  
mm)

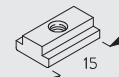

6141  
Track insert (uses  
screw 0798)

Brackets feature slot for screw M4x8

## Wall fitting with Blok bracket 0989

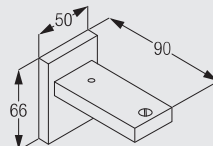
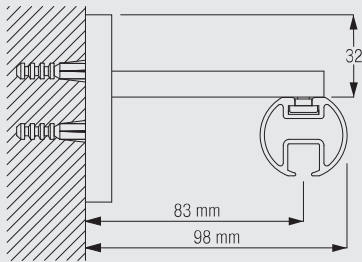

0989  
Blok Bracket

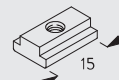

6141  
Track insert (uses  
screw 0798)

## Standard Accessories

### Parts

0346 Flush endcap (30mm)



6065 Twist eye endstop



6103 Profile



6141 Track insert (uses screw 0798)

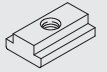

6143 Glider 6144 in strip form



6784 Machine screw (for 6141 insert)

6130M

11206 Smart Fix, 60 mm with slot set



11209 Smart Fix with extension arm set

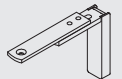

## Optional Accessories

### Parts

0311 Fused barrel (30mm)

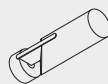

0324 Fused ball (30mm)



0331 Glass ball (30mm)



0334 Maxi adjustable bracket



0335 Top fix bracket



0556 Ball end finial (30 mm)



0629	Groove Cylinder (30mm)		0674	Pillar bracket (30 mm poles only)	
0707	End cover (30mm)		0719	Spear finial	
0770	Finial connecting bracket		0873	Design Endcap 30mm	
0886	Crystal cube (30mm pole)		0896	Crystal cylinder (30mm)	
0901	Strata (30mm)		0986	Groove Ball (30mm)	
0989	Blok Bracket		6283	Roller glider	
6635	Internal connecting bridge assembly		11207	Smart Fix, 80 mm with slot set	
11208	Smart Fix, 100 mm with slot set		11209	Smart Fix with extension arm set	
11216	Square Smart Fix, 60 mm with slot set		11217	Square Smart Fix, 80 mm with slot set	
11218	Square Smart Fix, 100 mm with slot set		6138p	Ceiling support set (3mm)	
0995CL	Shard Clear (30mm)		0995ET	Shard Etched (30mm)	

## Wave Accessories

6130M

3582	Hook		6007	Endstop	
6345	Wave glider cord (60mm)		6346	Wave glider cord (80mm)	
6349	Curtain tape		6363	Top hemming tape	
6364	Extension		6365	Hanger	
6366	Wave carrier for draw rod		10075	Lead weight 50 gr/m	
10076	Fabric weight		6098W	Wave roller glider cord (80mm)	

6130M

[www.silentgliss.co.uk](http://www.silentgliss.co.uk)  
[www.silentglissglobal.com](http://www.silentglissglobal.com)

Silent Gliss Ltd  
Pyramid Business Park  
Poorhole Lane  
Broadstairs  
Kent  
CT10 2PT  
Great Britain

Tel: +44 (0) 1843 863571  
Fax: +44 (0) 1843 864503  
[info@silentgliss.co.uk](mailto:info@silentgliss.co.uk)

Silent Gliss Global Ltd  
Pyramid Business Park  
Poorhole Lane  
Broadstairs  
Kent  
CT10 2PT  
Great Britain

Tel: +44 (0) 1843 874250  
Fax: +44 (0) 1843 874457  
[info@silentglissglobal.com](mailto:info@silentglissglobal.com)